

1951TM

Progressions



Specification Guide 2025

Beautifully Budget Friendly

Elevate the look of any space without going over budget. Our Progressions Cabinetry line features three distinct cabinet styles, complemented by three durable finishes.

NASH Modern simplicity meets everyday durability.

Our Nash cabinets bring a refined, minimalist look to today's homes. The partial overlay door design features a sleek white Thermofoil finish that delivers a smooth, seamless appearance perfect for contemporary or transitional spaces. With its clean lines and bright, polished feel, Nash creates a sense of openness and calm in any room. Built with long-lasting Thermofoil, this style resists chips, cracks, and everyday wear—offering a lasting, low-maintenance finish that looks effortlessly modern.

CODY Versatile. Bright. Inviting.

Our Cody cabinets bring effortless style and adaptability to any room. The clean Shaker design comes in two on-trend finishes: a crisp, versatile white that opens up spaces with light and simplicity, or a warm, earthy Pebble tone that adds depth and sophistication. Mix and match both colors for a personalized touch that feels fresh and timeless. Crafted from durable Thermofoil, Cody offers consistent color, smooth surfaces, and a finish that resists chipping and cracking—made for real-life durability with designer appeal.

GARRETT Rich warmth, timeless craftsmanship.

Our Garrett cabinets celebrate the natural beauty of high-quality hardwood, finished in a deep Umber stain that enhances the wood's grain and texture. The classic Shaker profile brings warmth, depth, and a handcrafted feel to any space. Pair Garrett's rich finish with soft, earthy accents—like sage green, honey yellow, or terracotta—for a space that feels both grounded and inviting. Designed for enduring beauty, Garrett blends traditional charm with modern versatility.

What's New for 2025

From a new Partial Overlay door to additional wall and base cabinet expansions to tall cabinets and an expanded cabinet line, discover all the new enhancements to our cabinetry line. Also, look for our parts directory at the back of this guide. If you have any questions, contact our Partner Team at **623.263.7825**.

For easy identification, we've highlighted the new offerings.

Door Style

Nash

Wall Cabinet Expansion

W3015 BUTT, W3615 BUTT, W3612x24 BUTT, W3618x24 BUTT, W3624x24 BUTT, W3936, W3942, B39

Base Cabinet Expansion

DSB36 BUTT, BLB39/45

Accessible Sink Base

ASB36 BUTT

Tall Cabinets

UT1884x24DP AS, UT1890x24DP AS, UT1896x24DP AS

Base Waste Basket Redesign

BWBB18-2

Hardware Expansion

KNOB 1173 and Pull 1701 are now also available in Matte Black, Modern Brushed Gold, and Polished Chrome

In keeping with our policy of continuous product refinement, 1951 Cabinetry reserves the right to change specifications in design and materials as conditions require.

Table of Contents

Door Styles & Cabinet Construction

Cody.....	4
Garrett	5
Nash	5
Cabinet Materials	6
Cabinet Opening Dimensions.....	6
Cabinet Construction.....	7
Cabinet Overlay Dimensions	8

Product Specifications

Wall Cabinets	10
Base Cabinets	11
Vanity Cabinets.....	13
Tall Cabinets.....	13
Accessory Items.....	14
Molding.....	16
Hardware	17
Important Information.....	18



ANSI/KCMA A101.1



1951 PROGRESSIONS
MEMBER CABINET MANUFACTURERS ASSOCIATION
ENVIRONMENTAL STEWARDSHIP PROGRAM (ESP)
ALL PRODUCTS IMPACT THE ENVIRONMENT.
FOR ESP PROGRAM DETAILS, VISIT 1951PROG.COM

All cabinetry manufactured by 1951 Progressions is certified by the Kitchen Cabinet Manufacturers Association (KCMA).

1951 Progressions has received certification by KCMA Environmental Stewardship Program on all products.

Door Styles

Cody

Cody has a remarkable impact on any living space, with its pure and pristine quality. It makes any room appear larger and more inviting, saturating its environment with a sense of spaciousness and airiness.

White is timeless and elegant, providing a blank canvas that harmonizes effortlessly with various design styles and color schemes. Its clean and bright aesthetic fosters a sense of serenity and freshness, especially in spaces such as kitchens. White is a versatile choice that allows for creativity and personalization, whether through contrasting accents or a minimalist, contemporary vibe.

Pebble is a fusion of warm brown and subtle gray, creating a unique and versatile aesthetic. The result is a rich, earthy hue that emanates a sense of comfort and sophistication. This finish strikes a harmonious balance between traditional and contemporary design, making it an ideal option for a variety of decor styles.

Finish	Code
--------	------

White	1SSW
-------	------

Pebble	1SDV
--------	------

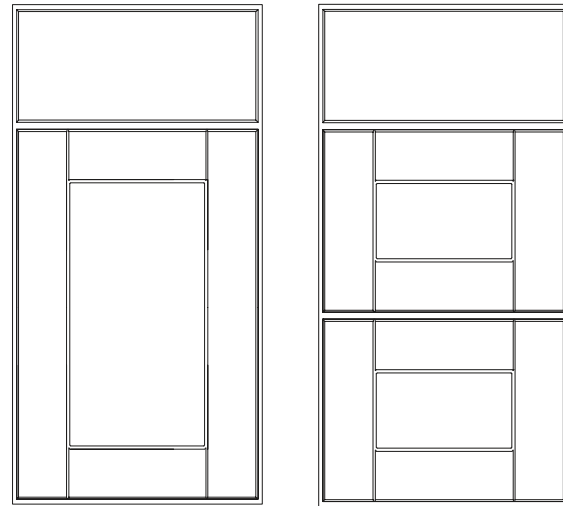

3"

Door Styles

Garrett

Garrett Umber gives a timeless elegance and warmth. It highlights the natural beauty of wood through its deep, earthy tones that convey a sense of authenticity and comfort. The intricate patterns and texture create a rich tactile and visual experience, making any space feel welcoming and cozy. Umber not only offers a classic and enduring appeal but also adds a touch of luxury.

Finish	Code
--------	------

Umber	1SJM
-------	------

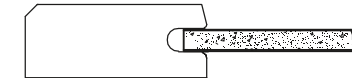
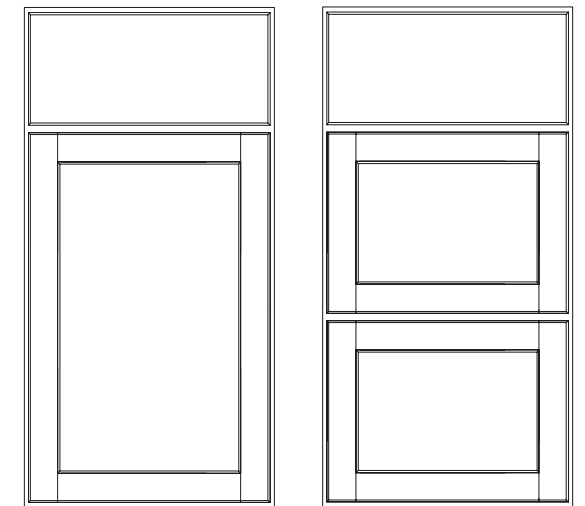

2"

Nash

NEW! DOOR STYLE

The Nash door blends timeless shaker simplicity with the clean, fresh appeal of a crisp white thermofoil finish. Its partial overlay design offers a classic touch, making it a versatile choice that complements both modern and traditional spaces. Durable, easy to maintain, and effortlessly stylish—Nash brings lasting beauty to every kitchen.

Finish	Code
--------	------

White	2SPW
-------	------

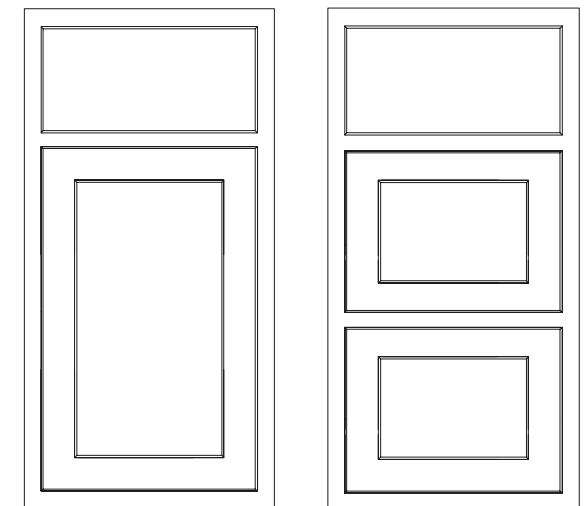

2 1/4"

Choosing Your Material

Hardwood

Hardwood cabinetry has a dense structure and comes from a combination of deciduous trees such as maple, beech, birch, or poplar. Natural colors range from light blonde to dark reddish-brown tones. These hardwoods may contain mineral streaks, slight differences in graining, and color variations.

Thermofoil

Thermofoil is a process whereby a thick vinyl film is bonded permanently to a warp-resistant engineered wood core. Because the color is consistent throughout the film, the surface is durable, easy to clean, and resistant to chipping and cracking.

Cabinet Opening Dimensions

Illustrations specify dimensions of vertical stiles and horizontal rails, inset toe kick, and standard interior opening heights. When selecting cabinetry for installation above or near any appliance, refer to the appliance manufacturer's specification for clearance and venting requirements.

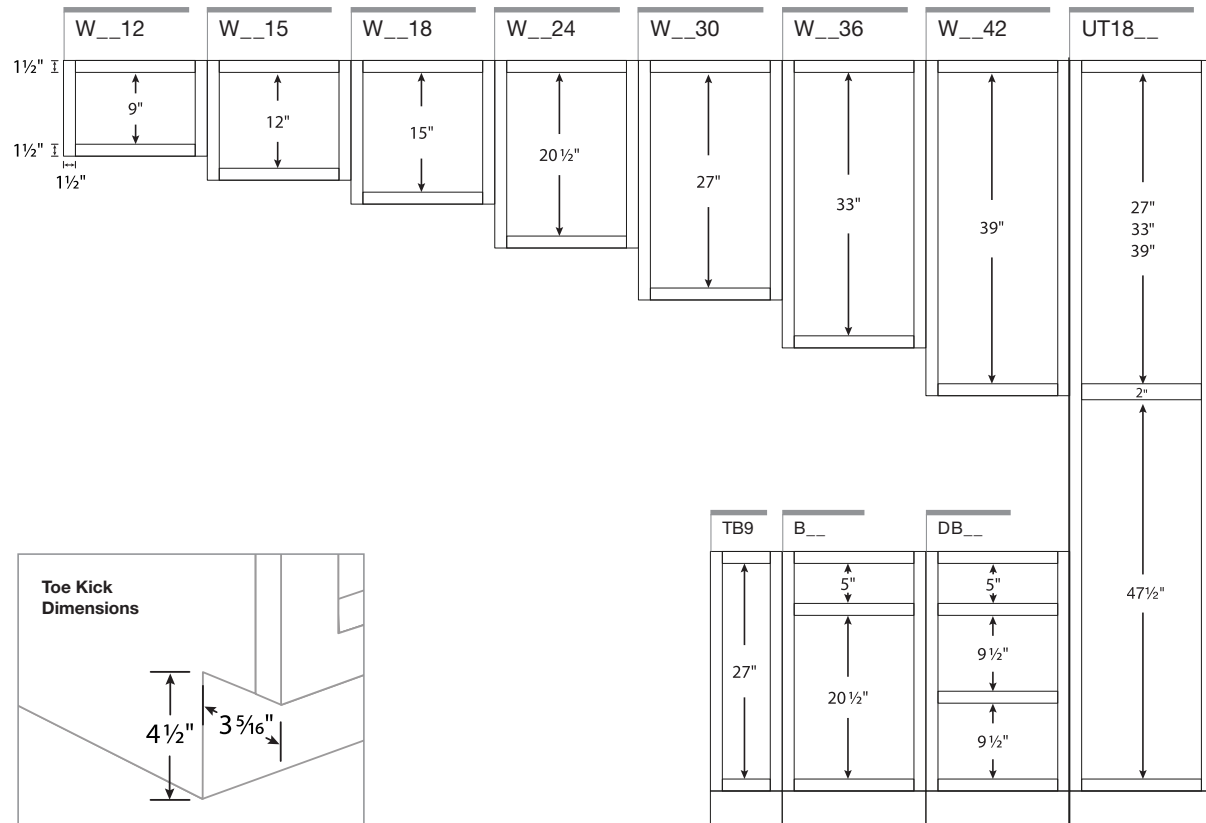

Cabinet Construction

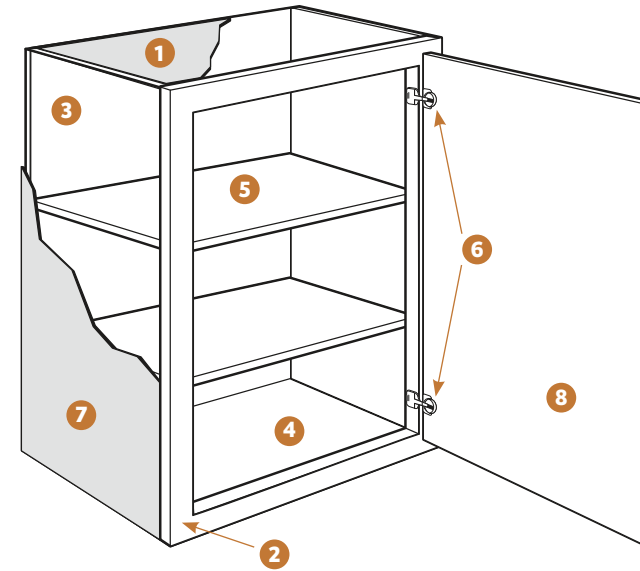

Wall Cabinets

- 1 Top/Bottom Panels:** 3/8" engineered wood
- 2 Face Frame:** 1 1/2" wide frame material
- 3 Back Panel:** Full 3/8" back panel
- 4 Interiors:** Natural wood-grain laminate finish on engineered wood
- 5 Shelves:** 3/4" thick adjustable shelves
- 6 Hinges:** Fully concealed and adjustable
- 7 End Panels:** 1/2" engineered wood with laminated exterior to match cabinet finish
- 8 Door:** Reversible door on single-door cabinets for left or right opening; hinged on the left from the factory; double-door cabinets are butt doors with no center stile (excluding 39" or wider)

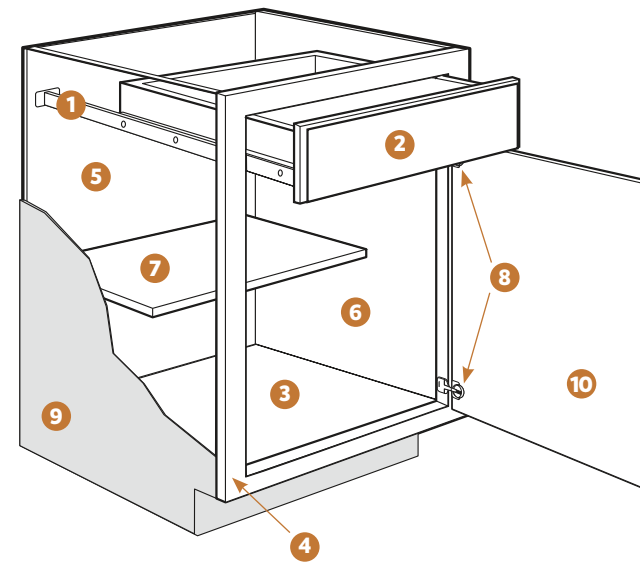

Base Cabinets

- 1 Drawer Glides:** 3/4" access ball bearing
- 2 Drawer Box:** Hardwood, 4-sided drawer box with fully encapsulated bottom
- 3 Bottom Panels:** 3/8" engineered wood
- 4 Face Frame:** 1 1/2" wide frame material
- 5 Back Panel:** Full 3/8" back panel with a natural laminate interior
- 6 Interiors:** Natural wood-grain laminate finish on engineered wood
- 7 Shelf:** 3/4" thick adjustable half-depth shelf
- 8 Hinges:** Fully concealed and adjustable
- 9 End Panels:** 1/2" engineered wood with laminated exterior to match cabinet finish
- 10 Door:** Reversible door on single-door cabinets for left or right opening; hinged on the left from the factory; double-door cabinets are butt doors with no center stile (excluding 39" or wider)

Cabinet Overlay Dimensions

Full Overlay

Full overlay doors are sized to cover nearly all of the cabinet face frame. Full overlay door styles require decorative hardware. To facilitate proper door operation, include at least a 1" filler between the hinged side of full overlay door styles and deeper adjacent objects including cabinets, walls, appliances, and countertops.

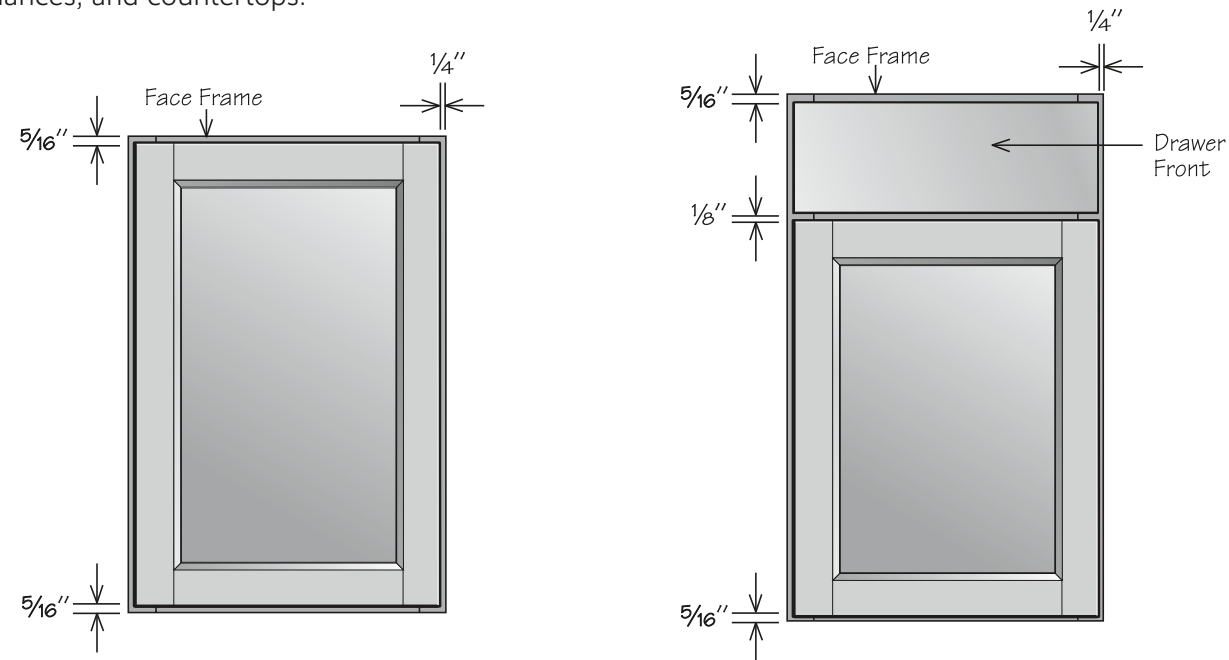

Partial Overlay **NEW!** OVERLAY

Partial Overlay (POL) doors are sized to show about an inch of the cabinet face frame, giving the doors some visual depth. Cabinets 39" wide will feature a center stile, creating a 2" gap between doors. Some door styles do not require decorative hardware.

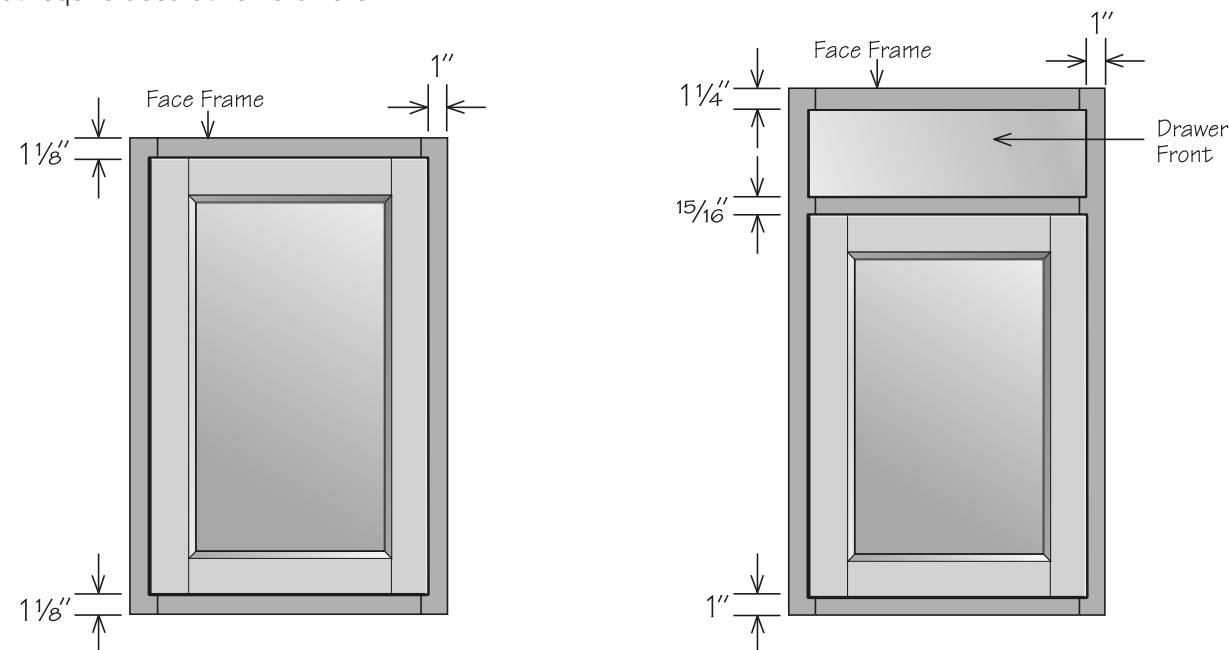

Product Specs

Create the kitchen that perfectly fits your lifestyle. You'll find the quality construction and features at prices that help you get the most kitchen for your budget—and years of enjoyment.

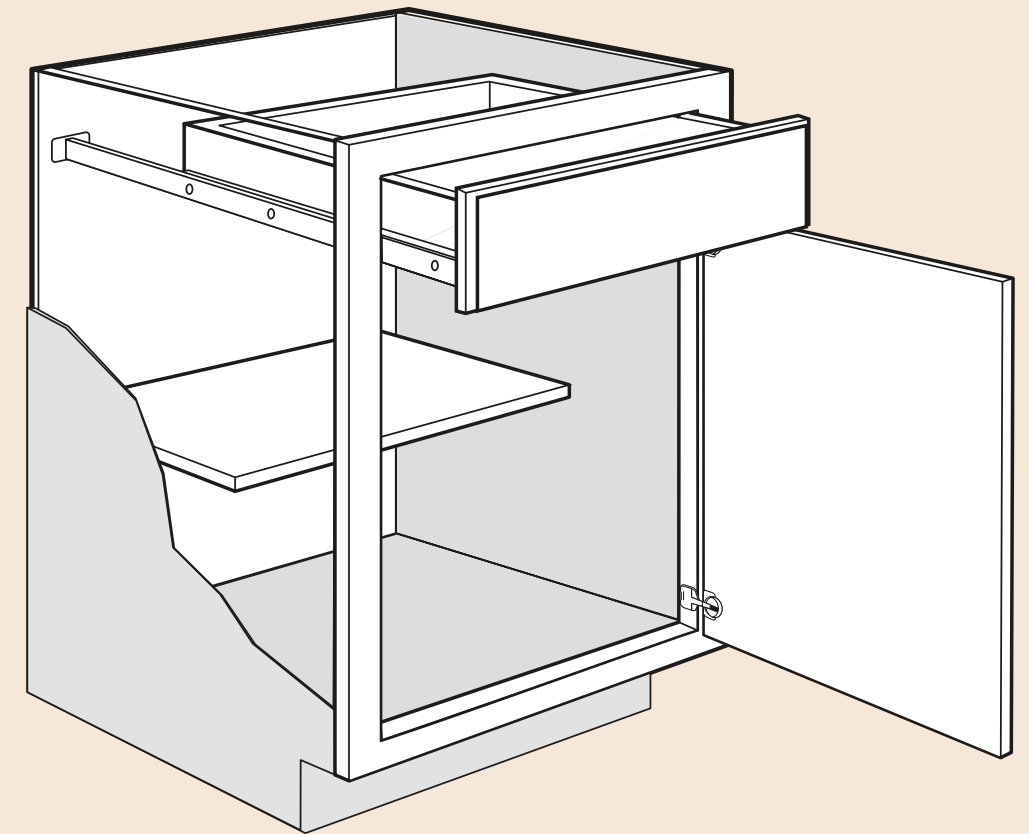

Wall Cabinet Specifications

Wall Cabinet | 1 Door

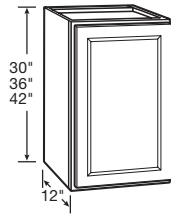

- Includes two adjustable shelves
- Hinged left, field reversible

30" HIGH	36" HIGH	42" HIGH
W1230	W1236	W1242
W1530	W1536	W1542
W1830	W1836	W1842
W2130	W2136	W2142
W2430	W2436	W2442

Wall Cabinet | 2 Butt Doors

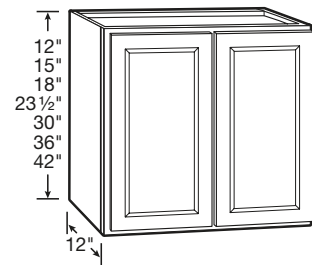

12" HIGH - No Shelf	15" HIGH - No Shelf	18" HIGH - No Shelf
W3012 BUTT	W3015 BUTT	W3018 BUTT
W3612 BUTT	W3615 BUTT	W3618 BUTT
24" HIGH - 1 Shelf	30" HIGH - 2 Shelves	36" HIGH - 2 Shelves
W3024 BUTT	W2730 BUTT	W2736 BUTT
W3624 BUTT	W3030 BUTT	W3036 BUTT
	W3330 BUTT	W3336 BUTT
42" HIGH - 2 Shelves	W3630 BUTT	W3636 BUTT
W2742 BUTT		
W3042 BUTT		
W3342 BUTT		
W3642 BUTT		

Wall Cabinet | 2 Doors

NEW! SIZES

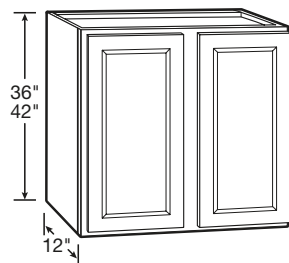

36" HIGH - 2 Shelves	42" HIGH - 2 Shelves
W3936	W3942

Refrigerator Wall Cabinet | 2 Butt Doors

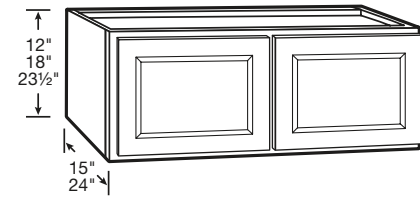

- Includes one adjustable shelf (where applicable)

12" HIGH - No Shelf	18" HIGH - No Shelf	24" HIGH - 1 Shelf
24" Deep	24" Deep	24" Deep
W3612X24DP BUTT	W3618X24DP BUTT	W3624X24DP BUTT
		15" Deep
		W3024X15DP BUTT

Corner Wall Cabinet

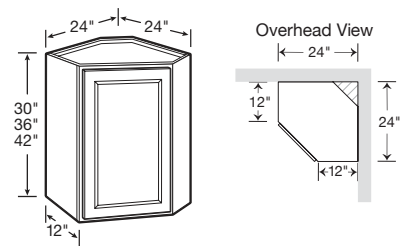

- Installs in a 24" x 24" wall area
- 30" high includes one adjustable shelf
- 36" high and 42" high include two adjustable shelves
- Hinged left, field reversible

30" HIGH	36" HIGH	42" HIGH
CW2430	CW2436	CW2442

Base Cabinet Specifications

Full-Height Base Cabinet | 1 Door

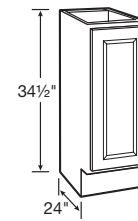

- One half-depth adjustable shelf included
- Hinged left, field reversible

34 1/2" HIGH
TB9

Base Cabinet | 1 Door and 1 Drawer

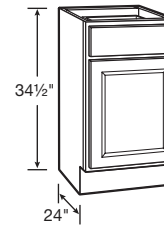

- Ball-bearing drawer glides
- One half-depth adjustable shelf included
- Hinged left, field reversible

34 1/2" HIGH	
B12	B21
B15	B24
B18	

Base Cabinet | 2 Butt Doors and 1 Drawer

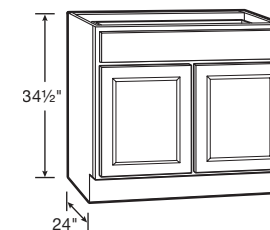

- Ball-bearing drawer glides
- One half-depth adjustable shelf included

34 1/2" HIGH
B27 BUTT
B30 BUTT
B33 BUTT
B36 1TD BUTT

Base Cabinet | 2 Butt Doors and 2 Drawers

NEW! SIZE

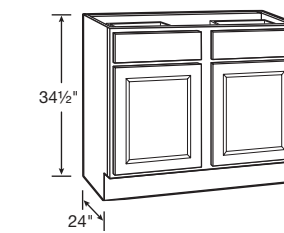

- Ball-bearing drawer glides
- One half-depth adjustable shelf included

34 1/2" HIGH
B39

Drawer Base Cabinet | 3 Drawers

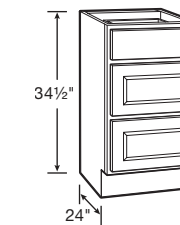

- 18" wide and 24" wide include ball-bearing drawer glides
- 30" wide and 36" wide include full-extension, heavy-duty drawer glides on all three drawers
- Deep drawers feature five-piece drawer fronts

34 1/2" HIGH	
DB18	DB30
DB24	DB36 1TD

Base Cabinet | 1 Door with Wastebasket Pull-Out and 1 Drawer

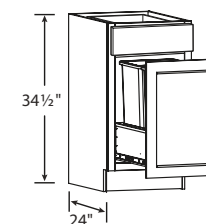

- Top drawer includes ball-bearing drawer glides
- Wastebasket pullout includes heavy-duty ball-bearing drawer glides and two 35-quart capacity bins

34 1/2" HIGH
BWBB18-2

Base Cabinet Specifications

Sink/Cooktop Base | 2 Butt Doors and 1 Panel

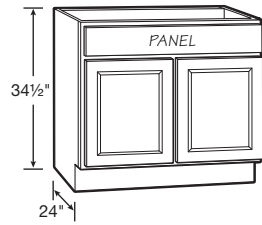

- Full-height back panel
- No shelf
- Subtract 1 1/2" from width and 1" from depth for available sink bowl opening
- Refer to sink/cooktop manufacturer's specifications for adequate clearance and required installation materials
- Touch-up kit included

34 1/2" HIGH

SB30 BUTT TU
SB36 BUTT TU

Deep Sink Base

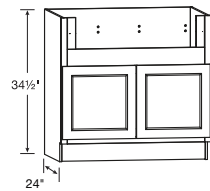

APRON CUTOUT DIMENSIONS			
ACTUAL WIDTH	MAX. WIDTH	ACTUAL HEIGHT	MAX. HEIGHT
29"	33"	7 1/2"	11"

- 2" stiles and 4" rail are trimmable to accommodate various size sinks/cooktops
- Smaller size sinks/cooktops can be accommodated with use of 3" or 6" filler
- No shelf

34 1/2" HIGH

DSB36 BUTT

Corner Base Carousel | Spin Unit

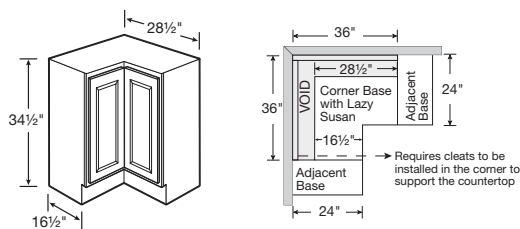

- Installs in a 36" x 36" wall area
- Two-piece overlay door hinged together in the middle
- Two 360° independently rotating metal racks
- Exterior side panels are natural laminate
- Hinged left, reversible in field
- Additional space recommended if appliance is installed on the hinged side of this cabinet for proper door operation
- If unit has an exposed side, order an end panel separately

34 1/2" HIGH

CAR36

Accessible Sink Base

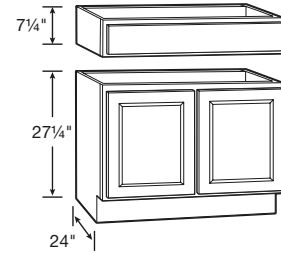

- Exterior side panels are natural maple laminate
- Features one false drawer front on detachable cabinet header
- No shelf

34 1/2" HIGH

ASB36 BUTT

Blind Base Cabinet

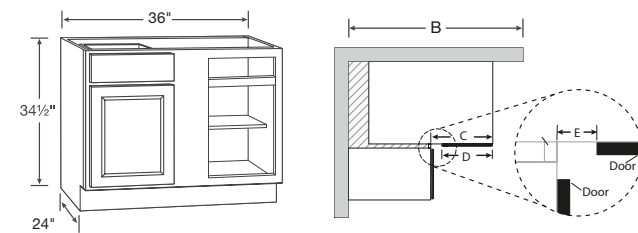

BLIND CABINET DIMENSIONS

OVERLAY	ACTUAL CABINET WIDTH	WALL SPACE		EXPOSED FRAME C*	DOOR WIDTH D	EXPOSED STILE E*
		MIN B	MAX B			
FULL	36"	40 1/8"	46 1/2"	18"	14 3/4"	3 1/8"
PARTIAL	36"	39 1/4"	46 1/2"	18"	13"	4"

*Only applies when cabinet is pulled to 42"

- Includes one half-depth adjustable shelf
- Door and drawer are reversible to accommodate left or right blind

34 1/2" HIGH

BLB39/45

Vanity Cabinet Specifications

Vanity Drawer Base | 3 Drawers

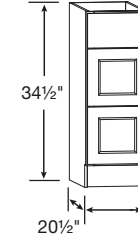

- Deep drawers feature five-piece drawer fronts

34 1/2" HIGH

VDB1234H
VDB1534H
VDB1834H

Vanity Sink Base | 2 Butt Doors and 1 Drawer Panel

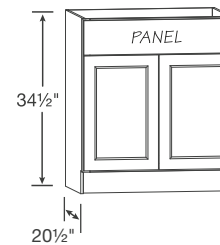

- No shelf
- Subtract 1 1/2" from width and 1 1/8" from depth for available sink bowl opening
- Refer to sink manufacturer's specifications for adequate clearance and required installation materials

34 1/2" HIGH

VSB2434H BUTT
VSB2734H BUTT
VSB3034H BUTT
VSB3334H BUTT
VSB3634H BUTT

Tall Cabinet Specifications

Pantry Cabinet | 24" Deep

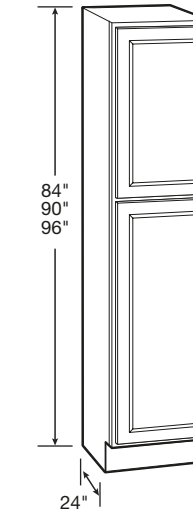

- Upper door lines up with 30", 36" and 42" high wall cabinets
- 84" and 90" includes three full-depth adjustable shelves and one full-depth fixed shelf
- 96" includes four full-depth adjustable shelves and one full-depth fixed shelf
- 96" has removable toe kick that is field installed

84" HIGH

UT1824X84 AS

90" HIGH

UT1824X90 AS

96" HIGH

UT1824X96 AS

Double Oven Cabinet | 2 Butt Doors and 1 Drawer

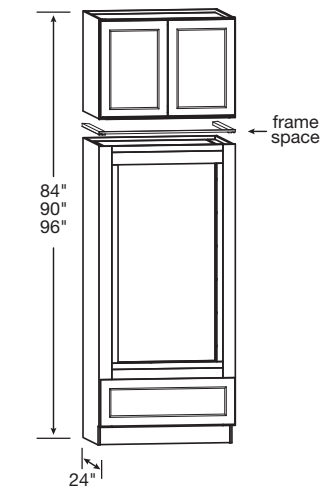

- Includes drawer with full-extension, heavy-duty drawer glides
- Includes 24" deep wall cabinet (ships separately)
- Overhead wall cabinet is not pre-installed to oven cabinet, comes as two pieces, boxed separately
- Rails and stiles around oven opening are trimmable
- Cut-out dimensions:
 - Width: 24" minimum, 30" maximum
 - Height: 47 1/8" minimum, 52 1/8" maximum
- Frame spacer included in OVD339624 BUTT only
- 96" high double oven overhead wall cabinet is 23 1/2" high

84" HIGH

OVD338424 BUTT

90" HIGH

OVD339024 BUTT

96" HIGH

OVD339624 BUTT

Accessory Item Specifications

Veneer End Paneling

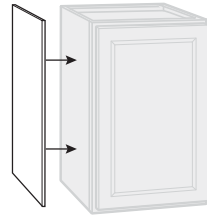

- Finished veneer panels fit flush
- Umber panels feature stained veneers
- White and Pebble panels are laminate
- Wall panels are 11¼" deep, 30" or 42" high
- Base panels are 23¼" deep x 34½" high
- Finished panel is 48" wide x 34½" high

WALL PANEL	BASE PANEL	FINISHED PANELING
WEP30 WEP42	BEP34	FP4834

Wall & Base Fillers

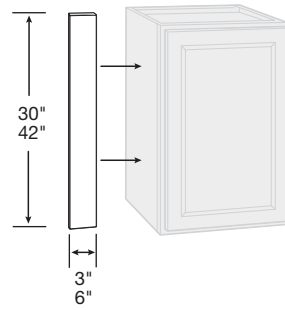

- ¾" thick
- Cody door styles feature wrapped-plywood finished on the face only
- Garrett door style features hardwood finished on the face only

3" FILLER	6" FILLER
UF3P UF342P	UF6P UF642P

Tall Filler



- ¾" thick
- Cody door styles feature wrapped-plywood finished on the face only
- Garrett door style features hardwood finished on the face only

91½" HIGH
UF392P

Refrigerator Return Kit

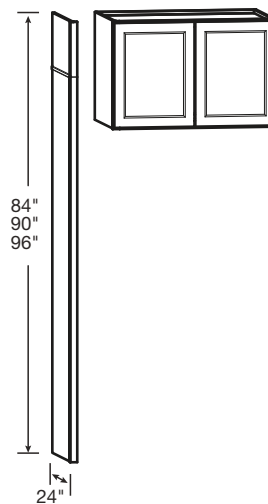

- Kit includes one 84" tall end panel, one 12" tall panel, one 6" tall panel, and one piece of scribe molding
- Kits and Wall Cabinets combine to achieve 84", 90", or 96" overall heights
- Panel seam may be visible in some design applications, depending on height and panel placement — concealed with included scribe molding
- Pairs with 36" wide wall cabinets, sold separately—see Wall Cabinets section
- Refrigerator Return Kit does not create a stand-alone cabinet; must be anchored to other cabinets/wall studs to be secure

96" HIGH
RR96

Accessory Item Specifications

Dishwasher Return

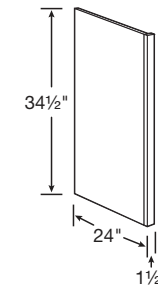

- Reversible for left or right installation
- Exterior finish to match
- Field trimmable to 1"
- Can be notched for toe kick in the field

34½" HIGH
DWR1_5

Decorative Matching Doors

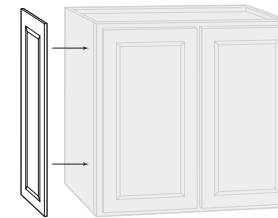

WALL			BASE
12" Deep	15" Deep	18" Deep	24" Deep
DMDW30 DMDW36 DMDW42	DMDW30 15D	DMDW30 18D	DMDB

Finished Shelves

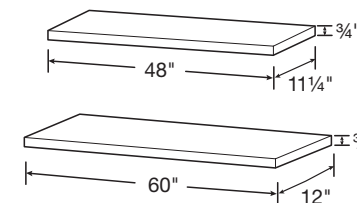

- ¾" depth difference between shelf lengths
- Laminate finish on five sides
- Finished on top, bottom, two short edges, and one long edge

48" WIDE	60" WIDE
11¼" Deep FS4812	12" Deep FS6012

Decorative Island End Panel Kit

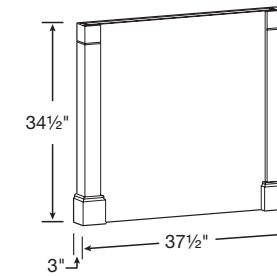

- One post ships loose
- Panel can be cut to accommodate different depths

34½" HIGH
ISLAND PANEL KIT

Sliding Shelf Kit

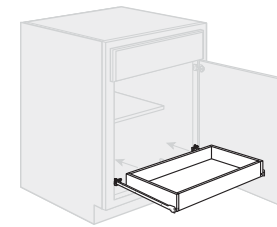

- Ball-bearing drawer glides
- Hardwood drawer box SSK24 fits in 24" wide base
- Hardwood drawer box SSK30 fits in 30" wide base
- Ready to assemble accessory kit requiring field installation
- Kit includes sliding shelf and all hardware

SSK24
SSK30

Countertop Corbel

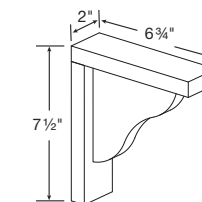

- For decorative use only

CS8

Accessory Item Specifications

Cleats

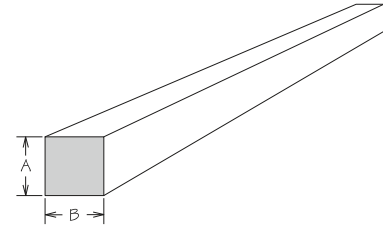

- Unfinished

	A	B	LENGTH
HWC 1/2X1/2X91.5	1/2"	1/2"	91 1/2"
HWC 3/4X3/4X91.5	3/4"	3/4"	91 1/2"
HWC 1X2X91.5	3/4"	1 1/2"	91 1/2"
HWC 2X4X91.5	1 1/2"	3 1/2"	91 1/2"

Toe Kick

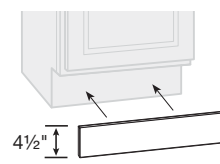

- 91 1/2" long

BTK8

Molding Specifications

Crown Moldings

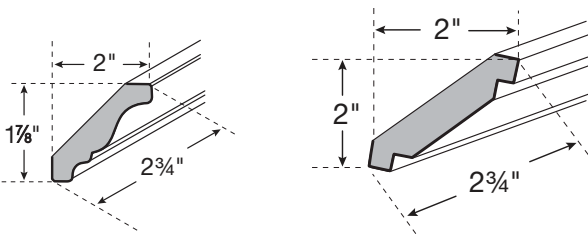

TRADITIONAL CROWN

SHAKER CROWN

- 91 1/2" long
- Bold line indicates finished surfaces

TRADITIONAL CROWN

CM8

SHAKER CROWN

ACM8

Molding Stock

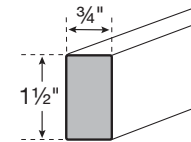

- 91 1/2" long
- Bold line indicates finished surfaces

SQUARE EDGE

SS1_596

Light Rail Molding

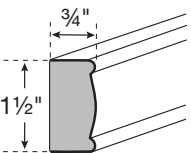

- 91 1/2" long
- Bold line indicates finished surfaces

DECORATIVE EDGE

LBM8

Molding Specifications

Base Molding

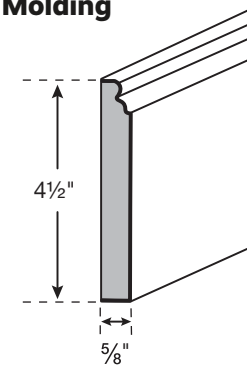

- 91 1/2" long
- Bold line indicates finished surfaces

BASE

CLBM8

Trim Molding

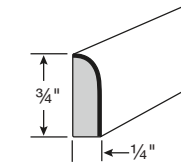

SCRIBE

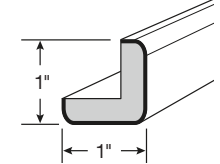

OUTSIDE CORNER

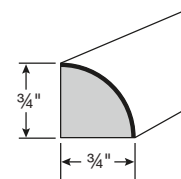

QUARTER ROUND

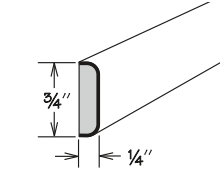

BATTEN

- 91 1/2" long
- Bold line indicates finished surfaces

SCRIBE

SM8

QUARTER ROUND

SHM8

OUTSIDE CORNER

OCM8

BATTEN

BM8

Hardware Specifications

Classic Knob



**Classic Knob
Polished Chrome**
KNOB 1173PC



**Classic Knob
Satin Nickel**
KNOB 1173SN



**Classic Knob
Modern Brushed Gold**
KNOB 1173MG



**Classic Knob
Matte Black**
KNOB 1173MB

T-Bar Pull



**T-Bar Pull
Polished Chrome**
PULL 1701PC
3" Center • Overall Length: 5"



**T-Bar Pull
Satin Nickel**
PULL 1701SN
3" Center • Overall Length: 5"



**T-Bar Pull
Modern Brushed Gold**
PULL 1701MG
3" Center • Overall Length: 5"



**T-Bar Pull
Matte Black**
PULL 1701MB
3" Center • Overall Length: 5"

Notes



A series of horizontal lines for writing notes, consisting of 25 evenly spaced lines that fill the majority of the page.



Service You've Come to Expect

Homeowners, contractors, and distributors all want value-priced cabinetry without compromising on service and support. With 1951 Progressions you'll get budget-friendly, high-quality cabinetry backed by the same level of service and support our customers have trusted from 1951 Cabinetry for seven decades.

Unmatched Experience and Craftsmanship

For more than 70 years, we've cared about the end product as much as you and your customers do. That's why we proudly back every 1951 Progressions cabinet with a limited lifetime warranty. With an emphasis on quality, 1951 Progressions offers two door styles and three finishes, so homeowners can enjoy lasting beauty and value for years to come.

1951TM
Progressions





1951[™]
Progressions

Questions?

Contact 11 Woods and Stone.
We are here for you.

623.263.7825

Monday – Friday 9:00 AM – 5:00 PM
MST

P.O. Box 357

San Tan Valley, Arizona 85140

www.1951Cabinetry.com/Progressions



Photography is for illustration purposes only. Actual colors may vary slightly due to the printing process. For actual color selections, please consult your 1951 Cabinetry representative. Every effort was made to ensure accuracy of the information contained herein at the time of printing; however, 1951 Cabinetry makes no representations to such accuracies. If you would like further clarification about any of our products or processes, please call the 1951 Cabinetry Partner Team.

51P SPEC GUIDE 11-25 ©2025 American Woodmark Corporation® and 1951 Cabinetry® are registered trademarks of the American Woodmark Corporation.